

LED VALUE FLOODLIGHT G3



Highlights:

- Available in 7 wattages, 10w,20w,30w,50w,100w, 150w &200w;
- IP65&IK06 protection;
- Long 30,000hrs lifetime

Application Areas:

- Architecture lighting;
- Security lighting;
- Public area;

Advancing Light

One of the World's leaders in general lighting for lighting professionals as well as end users, offering



A broad variety of LED luminaires



Advanced LED lamps



Intelligent, networked Smart Home & Smart Building solutions



Traditional light sources

LED VALUE FLOODLIGHT G3



Product features:

- Driver on board technology platform
- Available in 10w,20w,30w,50w,100w,150w and 200w
- Standard CCT: Standard 3000K & 6500K.4000K MTO
- High color rendering: CRI > 80
- High power factor: PF>0.90
- 100lm/w, 30,000hrs lifespan @35°C
- IP65,IK06 protected
- Safety compliance certificates: CB, EMC RoHS 2.0

Product benefits:

- Energy saving thanks to high system efficacy up to 100lm/w;
- Low windage thanks to the compact and slim design;
- Breather protects luminaires against the siphonage;
- Texture glass offer a comfortable lighting;
- IP65 protection is suitable for outdoor application;
- Long 30,000hrs lifetime reduces maintenance costs;



Application Areas:

- Parking lots;
- Sport field;
- Billboard lighting;
- Public area;

Product Information

LED VALUE Floodlight G3					
Electrical Data	Wattage (W)	10W	20W	30W	50W
	Voltage range	220 - 240VAC			
	Power factor	0.9			
	Input current	49mA	95mA	150mA	242mA
	Inrush current	7A	6A	6A	6A
	Inrush time	2.3us	1.3us	1us	1us
	Line frequency	50/60Hz			
	Surge Protection	L-N> 2000V, LN-G>2000V			
	THD	≤ 20 %			
	Protection class	Class I			
Optical / Photometric	Rated lumens	900lm ,3000K	1800lm ,3000K	2700lm ,3000K	4500lm ,3000K
		1000lm,4000K	2000lm,4000K	3000lm,4000K	5000lm,4000K
		1000lm,6500K	2000lm,6500K	3000lm,6500K	5000lm,6500K
	CCT (K)	3000K,4000 K&6500K			
	Beam angle	100°			
	CRI	80			
	SDCM	< 5			
	Efficacy	90lm/W @3000K,100lm/w @4000K 100lm/W @6500K			
	LED	SMD 2835			
	Rated lifetime	30,000 hrs @ L70 (Ta=35°C)			
Operating temperature	-30 ~ +50°C				
Storage temperature	-40 ~ +70°C				
Housing	Housing	Diecast Aluminum			
	Diffuser	Textured glass			
	IP &IK grade	IP 65 & IK 06			
	Power cord	0.5m			

Product Information

LED VALUE Floodlight G3				
Electrical Data	Wattage (W)	100W	150W	200W
	Voltage range	220 - 240VAC		
	Power factor	0.9		
	Input current	477mA	722mA	962mA
	Inrush current	9A	10A	11A
	Inrush time	1.9us	2.7us	3.6us
	Line frequency	50/60Hz		
	Surge Protection	L-N> 2000V, LN-G>2000V		
	THD	≤ 20 %		
	Protection class	Class I		
Optical / Photometric	Rated lumens	9000lm ,3000K	13500lm ,3000K	18000lm,3000K
		10000lm,4000K	15000lm,4000K	20000lm,4000K
		10000lm,6500K	15000lm,6500K	20000lm,6500K
	CCT (K)	3000K,4000 K&6500K		
	Beam angle	100°		
	CRI	80		
	SDCM	< 5		
	Efficacy	90lm/W @3000K,100lm/w @4000K 100lm/W @6500K		
	LED	SMD 2835		
	Rated lifetime	30,000 hrs @ L70 (Ta=35°C)		
Operating temperature	-30 ~ +50°C			
Storage temperature	-40 ~ +70°C			
Housing	Housing	Diecast Aluminum		
	Diffuser	Textured glass		
	IP & IK grade	IP 65 & IK 06		
	Power cord	0.5m		

Polar Intensity Diagram

10W

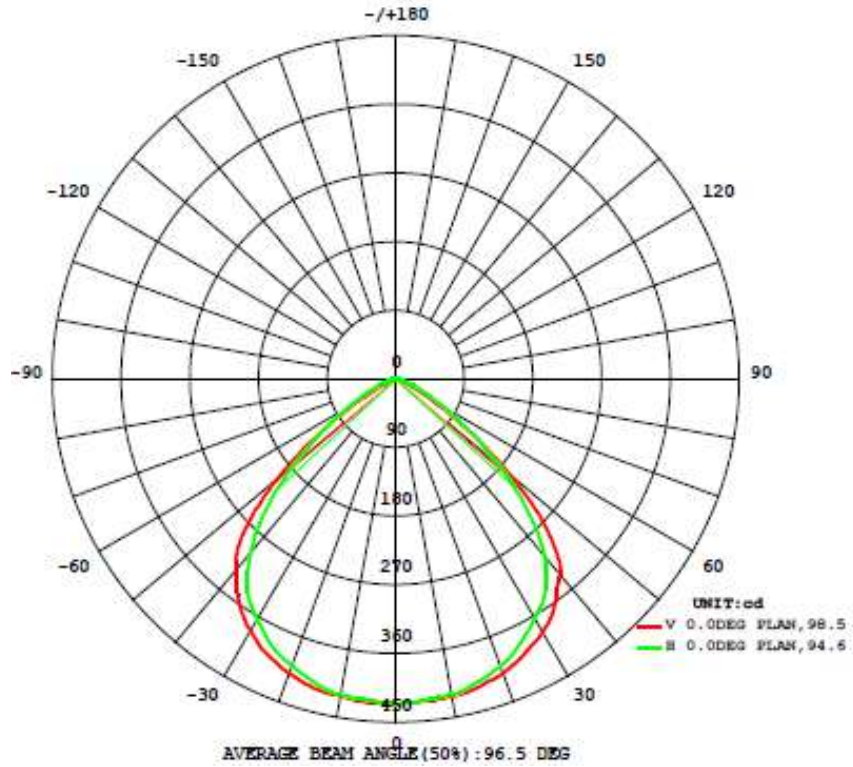

20W

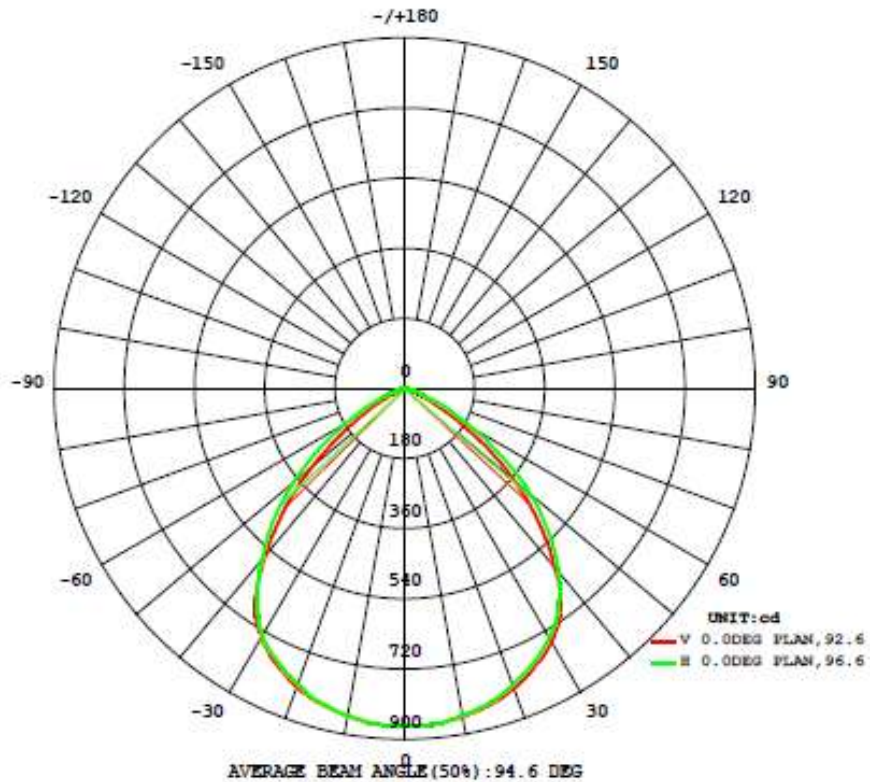

Polar Intensity Diagram

30W

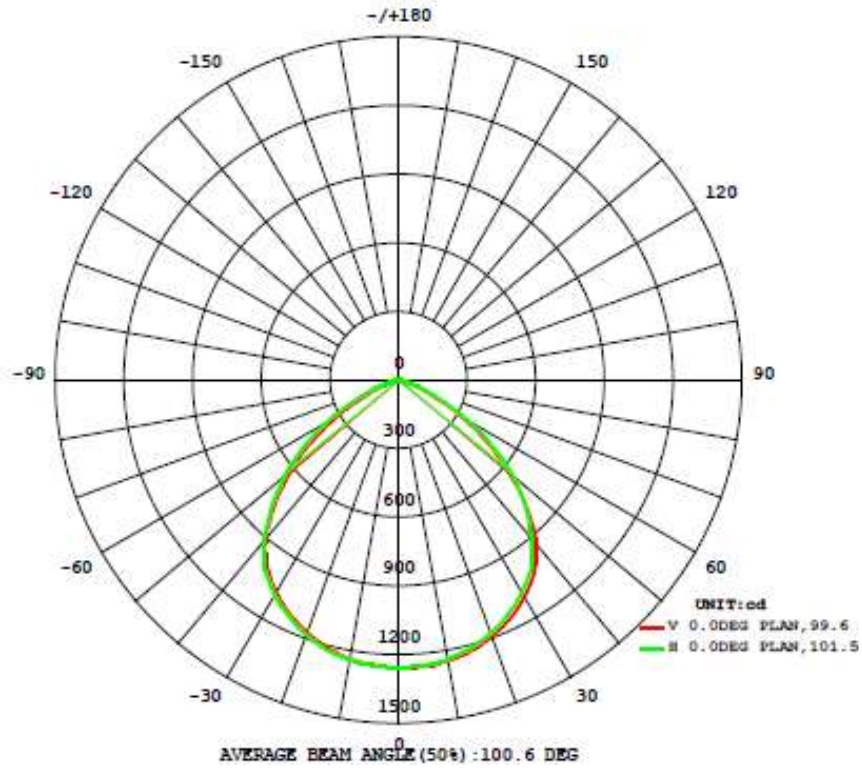

50W

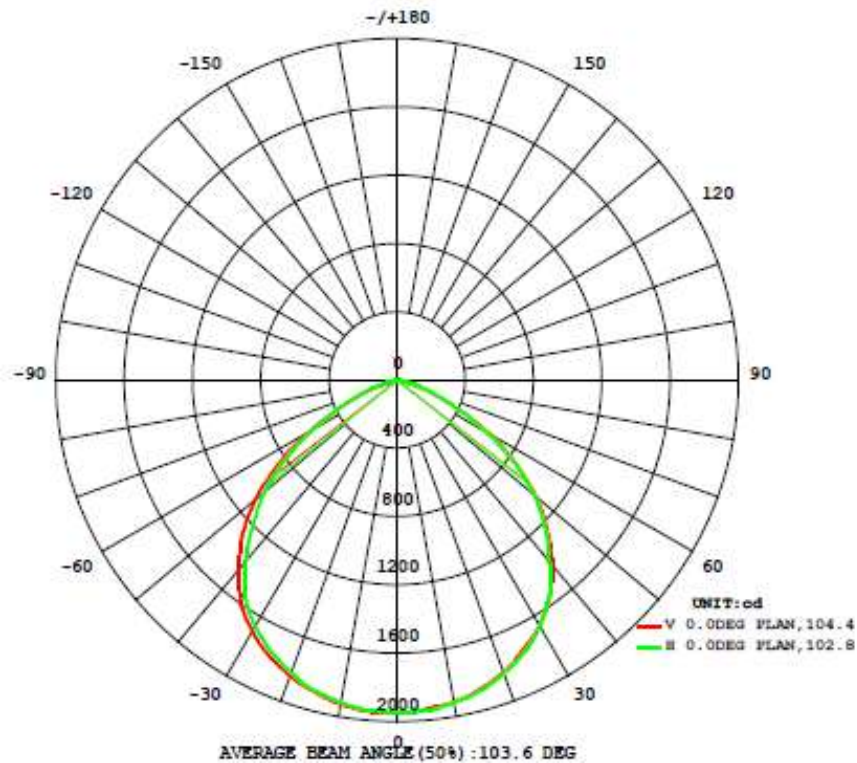

Polar Intensity Diagram

100W

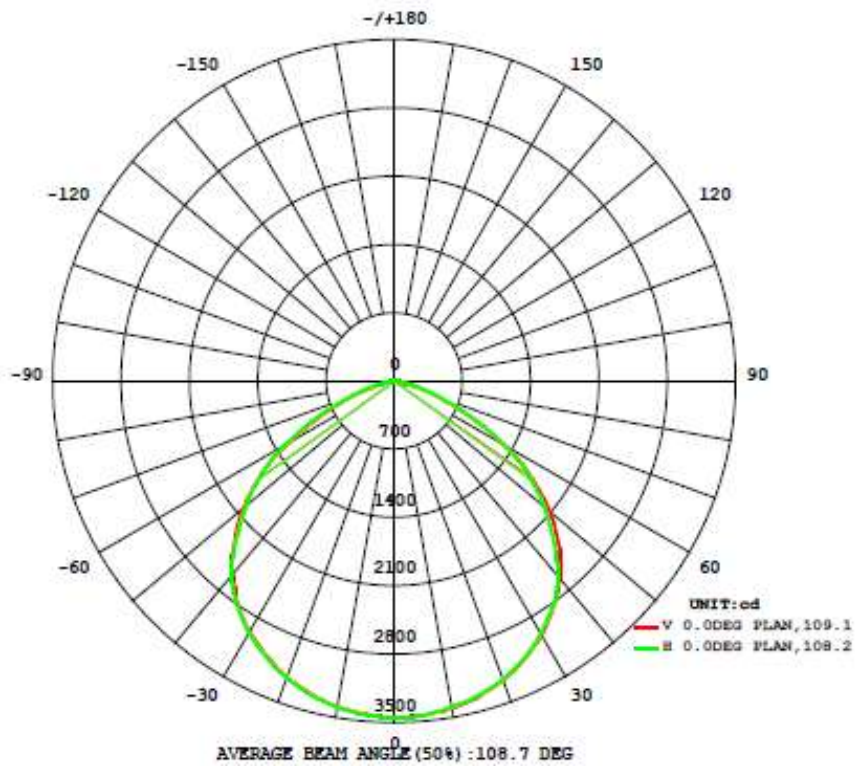

150W

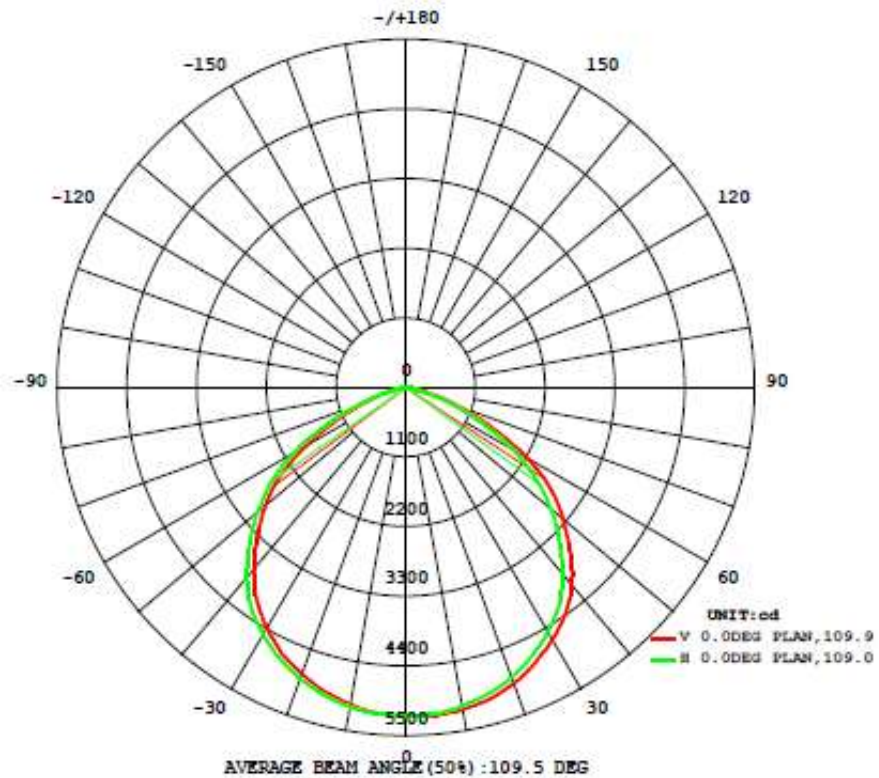

Polar Intensity Diagram

200W

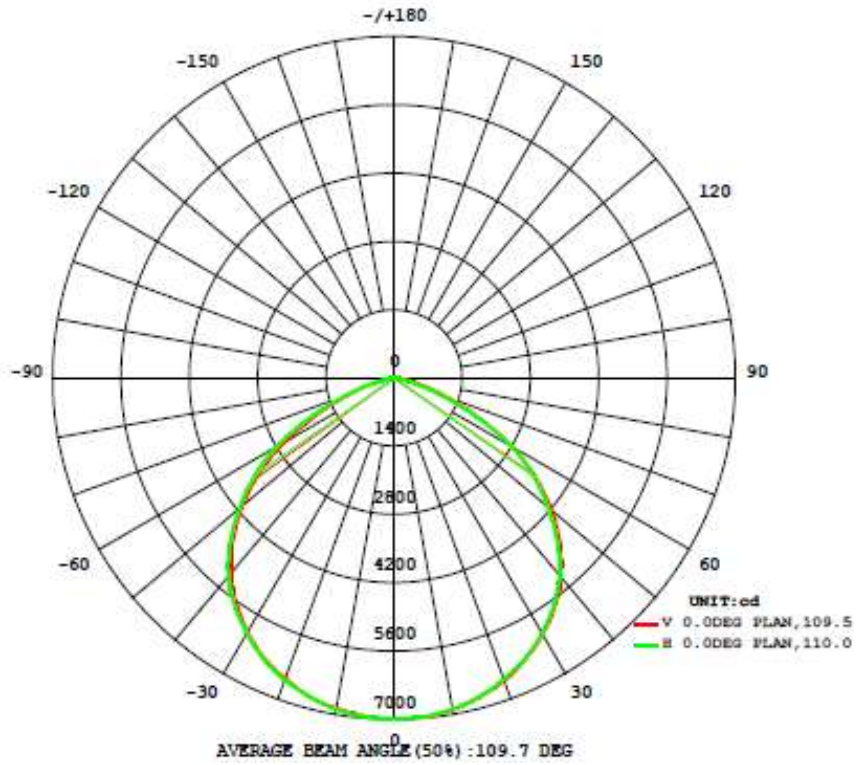

Drawing/Dimensions

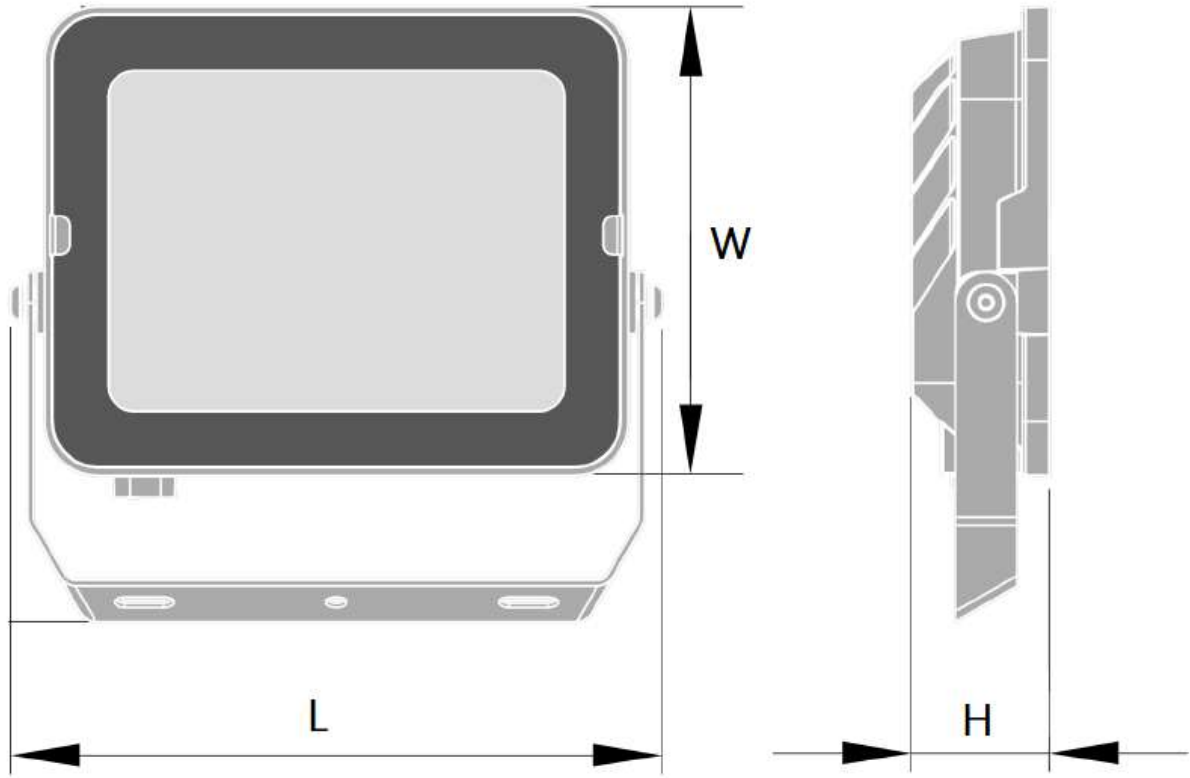

VALUE Floodlight G3	L(mm)	W(mm)	H(mm)	Weight(g)
10w	97	65	27	190
20w	109	78	29	220
30w	134	98	31	330
50w	170	122	36	560
100w	255	190	40	1250
150w	305	225	48	1850
200w	340	250	55	2520

Ordering Information

Description	Model Name	Shipping Quantity	EAN-10	EAN40
LDVAL FL 10W 830 G3 20X1 EN LEDV	V-FL-10W-G3-830	20	4058075589117	4058075589124
LDVAL FL 10W 840 G3 20X1 EN LEDV	V-FL-10W-G3-840		4058075589155	4058075589162
LDVAL FL 10W 865 G3 20X1 EN LEDV	V-FL-10W-G3-865		4058075589216	4058075589223
LDVAL FL 20W 830 G3 20X1 EN LEDV	V-FL-20W-G3-830	20	4058075589254	4058075589261
LDVAL FL 20W 840 G3 20X1 EN LEDV	V-FL-20W-G3-840		4058075589315	4058075589322
LDVAL FL 20W 865 G3 20X1 EN LEDV	V-FL-20W-G3-865		4058075589339	4058075589346
LDVAL FL 30W 830 G3 10X1 EN LEDV	V-FL-30W-G3-830	10	4058075589391	4058075589407
LDVAL FL 30W 840 G3 10X1 EN LEDV	V-FL-30W-G3-840		4058075589438	4058075589445
LDVAL FL 30W 865 G3 10X1 EN LEDV	V-FL-30W-G3-865		4058075589476	4058075589483
LDVAL FL 50W 830 G3 10X1 EN LEDV	V-FL-50W-G3-830	10	4058075589537	4058075589544
LDVAL FL 50W 840 G3 10X1 EN LEDV	V-FL-50W-G3-840		4058075589551	4058075589568
LDVAL FL 50W 865 G3 10X1 EN LEDV	V-FL-50W-G3-865		4058075589131	4058075589148
LDVAL FL 100W 830 G3 2X1 EN LEDV	V-FL-100W-G3-830	2	4058075589179	4058075589186
LDVAL FL 100W 840 G3 2X1 EN LEDV	V-FL-100W-G3-840		4058075589193	4058075589209
LDVAL FL 100W 865 G3 2X1 EN LEDV	V-FL-100W-G3-865		4058075589278	4058075589285
LDVAL FL 150W 830 G3 2X1 EN LEDV	V-FL-150W-G3-830	2	4058075589292	4058075589308
LDVAL FL 150W 840 G3 2X1 EN LEDV	V-FL-150W-G3-840		4058075589353	4058075589360
LDVAL FL 150W 865 G3 2X1 EN LEDV	V-FL-150W-G3-865		4058075589414	4058075589421
LDVAL FL 200W 830 G3 2X1 EN LEDV	V-FL-200W-G3-830	2	4058075589452	4058075589469
LDVAL FL 200W 840 G3 2X1 EN LEDV	V-FL-200W-G3-840		4058075589513	4058075589520
LDVAL FL 200W 865 G3 2X1 EN LEDV	V-FL-200W-G3-865		4058075589575	4058075589582